

MB1F-05~MB10F-05

Rev.D May.-2017

描述 / Descriptions

0.5A 表面贴装玻璃钝化整流桥，薄型 MBF 封装。

0.5A Surface Mount Glass Passivated Bridge Rectifier, MBF thin package.

特征 / Features

玻璃钝化芯片，反向电压：100V~1000V，正向电流：0.5A，浪涌电流大，适用于表面贴装。无卤产品。

Glass Passivated Chip Junction, Reverse Voltage:100to1000V, Forward Current: 0.5A, High Surge Current Capability, Designed for Surface Mount Application.Halogen free product.

用途 / Applications

一般用途。

General purpose.

内部等效电路 / Equivalent Circuit

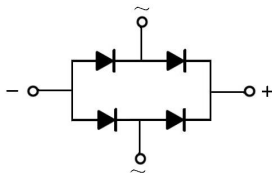

引脚排列 / Pinning



PIN	DESCRIPTION
1	Input Pin (~)
2	Input Pin (~)
3	Output Anode (+)
4	Output Cathode (-)

The recommended mounting pad size

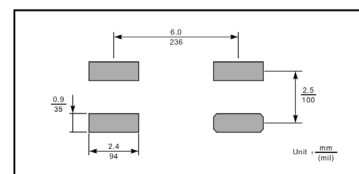

印章代码 / Marking

见印章说明。See Marking Instructions.

极限参数 / Absolute Maximum Ratings(Ta=25°C)

参数 Parameter	符号 Symbol	数值 Rating						单位 Unit
		MB1F-05	MB2F-05	MB4F-05	MB6F-05	MB8F-05	MB10F-05	
Maximum Recurrent Peak Reverse Voltage	V_{RRM}	100	200	400	600	800	1000	V
Maximum RMS Voltage	V_{RMS}	70	140	280	420	560	700	V
Maximum DC Blocking Voltage	V_{DC}	100	200	400	600	800	1000	V
Average Rectified Output Current at Ta = 50°C	$I_{F(AV)}$	0.5						A
Peak Forward Surge Current, 8.3ms Single Half Sine-wave Superimposed on Rated Load (JEDEC method)	I_{FSM}	20						A
Typical Junction Capacitance ¹⁾	C_j	13						pF
Typical Thermal Resistance ²⁾	$R_{\theta JA}$	120						°C/W
	$R_{\theta JL}$	35						
Operating and Storage Temperature Range	T_j, T_{stg}	-55~+150						°C

Note:

1. Measured at 1MHz and applied reverse voltage of 4 V D.C.
2. Mounted on glass epoxy PC board with 4×(5×5mm²) copper pad.

电性能参数 / Electrical Characteristics(Ta=25°C)

参数 Parameter	符号 Symbol	测试条件 Test Conditions	数值 Rating	单位 Unit
Max Instantaneous Forward Voltage	V_F	$I_F=0.5A$	1.1	V
Maximum DC Reverse Current at Maximum DC Blocking Voltage	I_R	$T_a=25^\circ C$	5.0	μA
		$T_a=125^\circ C$	40	μA

电参数曲线图 / Electrical Characteristic Curve

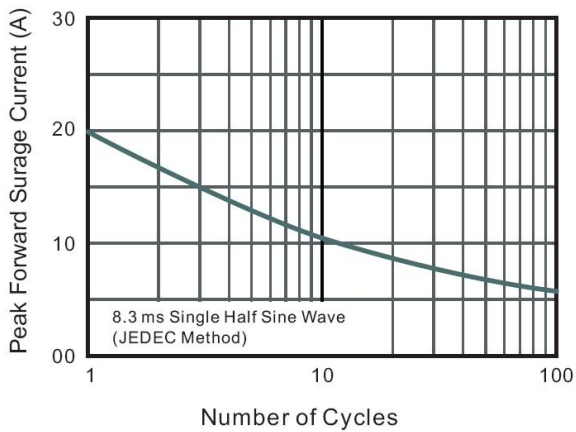
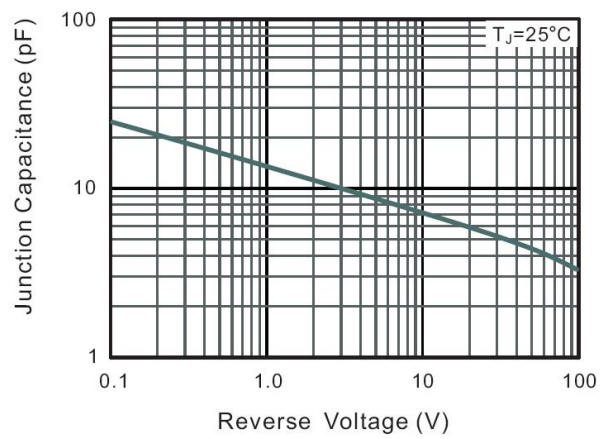
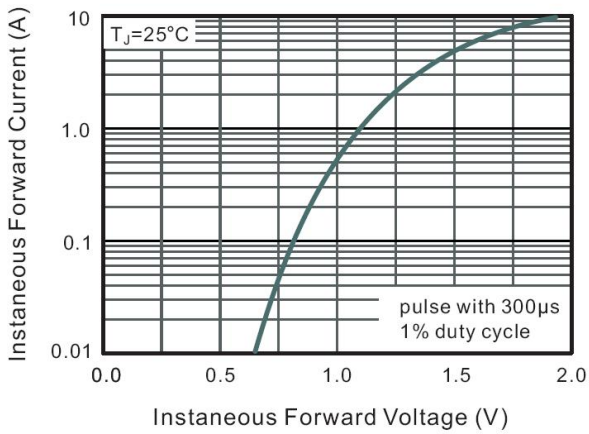
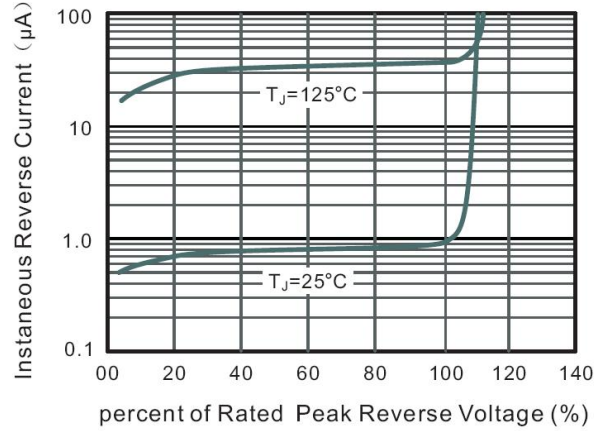
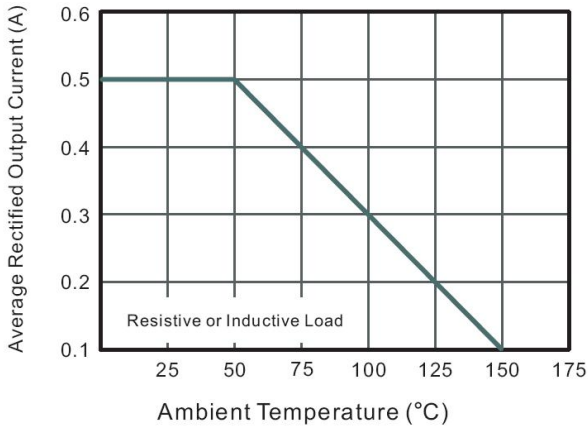

外形尺寸图 / Package Dimensions

MBF

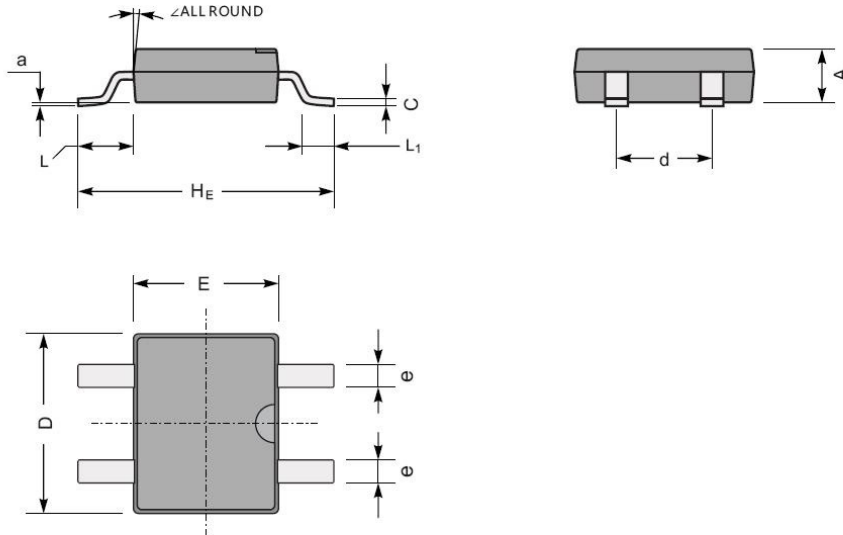

MBF mechanical data

UNIT		A	C	D	E	HE	d	e	L	L ₁	a	∠
mm	max	1.6	0.22	5.0	4.1	7.0	2.7	0.7	1.7	1.1	0.2	7°
	min	1.2	0.15	4.5	3.6	6.4	2.3	0.5	1.3	0.5	—	
mil	max	63	8.7	197	161	276	106	28	67	43	8	
	min	47	5.9	177	142	252	91	20	51	20	—	

印章说明 / Marking Instructions

Marking

Type number	Marking code
MB1F-05	05M1
MB2F-05	05M2
MB4F-05	05M4
MB6F-05	05M6
MB8F-05	05M8
MB10F-05	05M10

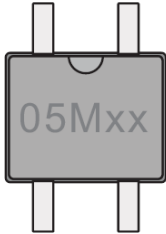

The diagram shows a rectangular component with four pins (two on top, two on bottom). The marking '05Mxx' is printed on the front face of the component.

印章说明 / Marking Instructions

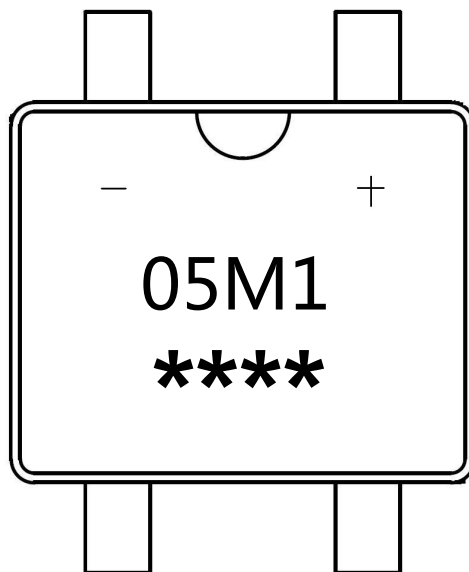

说明

05M1 : 为型号代码

**** : 为生产批号追溯码，第1个*为年月代码，后面3个*为当月小批号代码

Note:

05M1 : Product Type Code

**** : Lot No. Code , The 1st * means:YM Code , The last 3 * means:little Lot No Code

回流焊温度曲线图(无铅) / Temperature Profile for IR Reflow Soldering(Pb-Free)



说明：

- 1、预热温度 25 ~ 150°C，时间 60 ~ 90sec;
- 2、峰值温度 245±5°C，时间持续为 5±0.5sec;
- 3、焊接制程冷却速度为 2 ~ 10°C/sec.

Note:

- 1.Preheating:25~150°C, Time:60~90sec.
- 2.Peak Temp.:245±5°C, Duration:5±0.5sec.
3. Cooling Speed: 2~10°C/sec.

耐焊接热试验条件 / Resistance to Soldering Heat Test Conditions

温度：260±5°C

时间：10±1 sec.

Temp.:260±5°C

Time:10±1 sec

包装规格 / Packaging SPEC.

卷盘包装 / REEL

Package Type 封装形式	Units 包装数量					Dimension 包装尺寸 (unit: mm ³)		
	Units/Reel 只/卷盘	Reels/Inner Box 卷盘/盒	Units/Inner Box 只/盒	Inner Boxes/Outer Box 盒/箱	Units/Outer Box 只/箱	Reel	Inner Box 盒	Outer Box 箱
MBF	5000	2	10000	5	50000	13" × 15"	336X336X40	380X335X366

使用说明 / Notices